

2-Symmetric Transformations for 3-Manifolds of Genus 2¹

Luigi Grasselli

*Department of Sciences and Methods for Engineering,
University of Modena and Reggio Emilia,
42100 Reggio Emilia, Italy
E-mail: grasselli.luigi@unimo.it*

Michele Mulazzani²

*Department of Mathematics, University of Bologna, I-40127 Bologna, Italy
E-mail: mulazza@dm.unibo.it*

and

Roman Nedela³

*Department of Mathematics, M. Bel University, 97549 Banská Bystrica, Slovakia
E-mail: nedela@bb.sanet.sk*

Received November 24, 1997

As previously known, all 3-manifolds of genus 2 can be represented by edge-coloured graphs uniquely defined by 6-tuples of integers satisfying simple conditions. The present paper describes an elementary transformation on these 6-tuples which changes the associated graph but does not change the represented manifold. This operation is a useful tool in the classification problem for 3-manifolds of genus 2; in fact, it allows an equivalence relation to be defined on admissible 6-tuples so that equivalent 6-tuples represent the same manifold. Different equivalence classes can represent the same manifold; however, equivalence classes “almost always” contain infinitely many 6-tuples. Finally, minimal representatives of the equivalence classes are described. © 2000 Academic Press

Key Words: manifolds; genus; crystallizations.

¹ Work performed under the auspices of GNSAGA of CNR of Italy; supported by the MURST of Italy, within the project *Topologia e Geometria*, and by the University of Bologna, funds for selected research topics.

² Also, CIRAM, Bologna, Italy.

³ Supported in part by the Ministry of Education of Slovakia, Grant No. 1/3213/96.

1. INTRODUCTION

A classical invariant for closed 3-manifolds is the Heegaard genus [12]. It is well known that the only 3-manifold of genus 0 is the 3-sphere and the 3-manifolds of genus 1 are $\mathbf{S}^1 \times \mathbf{S}^2$, $\mathbf{S}^1 \tilde{\times} \mathbf{S}^2$ and the lens spaces. Thus, all 3-manifolds of genus < 2 are completely classified. On the contrary, the classification problem for the 3-manifolds of genus g is still unsolved for $g \geq 2$. The present paper deals with the classification problem for the class \mathcal{M}_2 of all orientable 3-manifolds of genus 2.

PL-manifolds can be represented by edge-coloured graphs [8] and within this theory the homeomorphism problem between manifolds can be translated into an equivalence criterion for edge-colored graphs by means of the so-called “dipole moves” [7]; namely, two manifolds are homeomorphic if and only if each pair of coloured graphs representing them can be joined by a finite sequence of dipole moves.

The Heegaard genus of a 3-manifold can also be defined in terms of coloured graphs; in fact, the Heegaard genus of a 3-manifold M is the non-negative integer $g(M) = \min\{g(G) \mid G \text{ represents } M\}$, where $g(G)$ is the minimal genus of a surface into which the coloured graph G regularly embeds [9], [10].

In particular, each manifold of \mathcal{M}_2 can be represented by highly symmetric graphs, which are uniquely defined by 6-tuples of integers. The classification problem in \mathcal{M}_2 then translates into determining when two 6-tuples represent the same manifold. Unfortunately, the dipole moves generally modify the genus of a coloured graph; hence, single dipole moves cannot be used for defining an equivalence criterion on 6-tuples, which translates the homeomorphism of the represented manifolds of \mathcal{M}_2 .

We point out that, up to now, the problem of finding a complete set of moves translating the homeomorphism between manifolds in \mathcal{M}_2 is still open in all known representation theories for \mathcal{M}_2 .

Our paper describes an elementary transformation on 6-tuples representing the manifolds of \mathcal{M}_2 which changes the associated graph but does not change the represented manifold; this is performed by standard sequences of dipole moves which do not change both the genus and the symmetry of the coloured graph.

This elementary transformation allows us to define an equivalence relation on 6-tuples so that equivalent 6-tuples represent the same manifold. Different equivalence classes can represent the same manifold; however, the transformation seems to be a useful tool for computer generating of reduced catalogues of \mathcal{M}_2 . In fact, we show that almost every manifold in \mathcal{M}_2 can be represented by infinitely many equivalent 6-tuples; moreover, we describe the minimal representatives of the equivalence classes.

2. PRELIMINARIES

Throughout this paper, all spaces and maps are piecewise-linear (PL) in the sense of [18]. Manifolds are always assumed to be closed, connected and orientable. For basic graph theory, we refer to [11]. We shall use the term graph instead of multigraph: hence, loops are forbidden but multiple edges are allowed.

An *edge-coloring* on a graph $\Gamma = (V(\Gamma), E(\Gamma))$ is a map $\gamma: E(\Gamma) \rightarrow \Delta_n = \{0, 1, \dots, n\}$ such that $\gamma(e) \neq \gamma(f)$, for each pair of adjacent edges e, f . If v, w are the vertices of an edge $e \in E(\Gamma)$ such that $\gamma(e) = c$, we say that e is a c -edge and that v, w are c -adjacent. The pair (Γ, γ) , Γ being a graph and $\gamma: E(\Gamma) \rightarrow \Delta_n$ being an edge-coloring, is said to be an $(n+1)$ -coloured graph with boundary. A boundary-vertex is simply a vertex v of degree less than $n+1$; if there are no c -edges incident with v , we say that v is a boundary vertex with respect to colour c . If Γ is regular of degree $n+1$ (i.e., if Γ has no boundary vertices), then (Γ, γ) is simply called an $(n+1)$ -coloured graph. The notion of *colour preserving isomorphism* (*c.p.-isomorphism*) between $(n+1)$ -coloured graphs is straightforward.

For each $\mathcal{B} \subseteq \Delta_n$, we set $\Gamma_{\mathcal{B}} = (V(\Gamma), \gamma^{-1}(\mathcal{B}))$; moreover, each connected component of $\Gamma_{\mathcal{B}}$ will be called a \mathcal{B} -residue. For each colour $c \in \Delta_n$, we set $\hat{c} = \Delta_n - \{c\}$. For sake of conciseness, we shall often denote (Γ, γ) simply by the symbol Γ of its underlying graph.

As shown in [8], every $(n+1)$ -coloured graph (with boundary) Γ represents an n -dimensional pseudocomplex $K(\Gamma)$ [13], which is a pseudomanifold (with boundary) [19]; moreover, $K(\Gamma)$ is orientable if and only if Γ is bipartite. An n -gem is an $(n+1)$ -coloured graph representing an n -manifold.

An $(n+1)$ -coloured graph Γ is said to be *contracted* if Γ_c is connected, for each $c \in \Delta_n$. A *crystallization* is a contracted gem. Every n -manifold admits a crystallization [17].

Let Γ be an $(n+1)$ -coloured graph and let θ be the subgraph composed by two vertices X, Y joined by h edges ($1 \leq h \leq n$) with colours c_1, \dots, c_h . If X and Y belong to distinct components of $\Gamma_{\Delta_n - \{c_1, \dots, c_h\}}$, then θ is called a *dipole of type h* .

Cancelling θ means:

- deleting the vertices and the edges of θ ,
- welding the “hanging” edges of the same colour.

Adding θ means the inverse process. If Γ and Γ' are n -gems of the n -manifolds M and M' respectively, then M' is homeomorphic to M if and only if Γ' is obtained from Γ by cancelling and/or adding a finite number of dipoles [7].

For a general survey on manifold representation theory by means of coloured graphs, see [1, 8, 15, 20].

3. BLOCKS AND GLUING SUBGRAPHS

Let Γ be a 4-coloured graph and let p, q, r be distinct colours of Δ_3 . Suppose that C' and C'' are distinct $\{p, q\}$ -residues of Γ and that v'_1, \dots, v'_h (resp. v''_1, \dots, v''_h) are distinct consecutive vertices of a $\{p, q\}$ -residue C' (resp. C''); this means that, for each $i=1, \dots, h-1$, v'_i (resp. v''_i) is joined with v'_{i+1} (resp. v''_{i+1}) by an edge a'_i of C' (resp. a''_i of C''). Moreover, suppose that $\gamma(a'_i) = \gamma(a''_i)$, for each $i=1, \dots, h-1$, and v'_j is joined with v''_j by an r -coloured edge b_j , for each $j=1, \dots, h$. Then, the subgraph Ω of Γ defined by

$$V(\Omega) = \{v'_1, \dots, v'_h, v''_1, \dots, v''_h\},$$

$$E(\Omega) = \{a'_1, \dots, a'_{h-1}, a''_1, \dots, a''_{h-1}, b_1, \dots, b_h\},$$

is called a $(\{p, q\}, r)$ -block of length h , connecting C' with C'' (see Fig. 1).

The vertices v'_1, v''_1, v'_h, v''_h are said to be the *corners* of the block and the two $\{p, q\}$ -residues of Ω are called the *sides* of the block. We shall often sketch the block Ω as in Fig. 2.

If C' and C'' are oriented, then a block Ω of length $h > 1$ is said to be *coherent* with these orientations if, denoted by v' and w' the two corners of Ω belonging to C' so that the orientation induced on the side goes from v' to w' , then the orientation induced on the other side goes from w'' to v'' , where w'' and v'' are the vertices r -adjacent to w' and v' respectively. In this case the vertices v' and w'' are said to be the *key-vertices* of the coherent block (see Fig. 2). Each block of length $h=1$ is considered coherent and both its vertices are key-vertices.

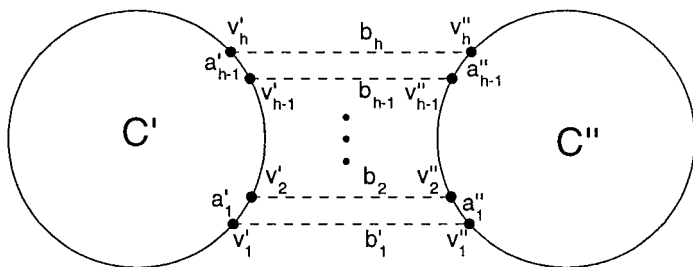

FIG. 1. A $(\{p, q\}, r)$ -block.

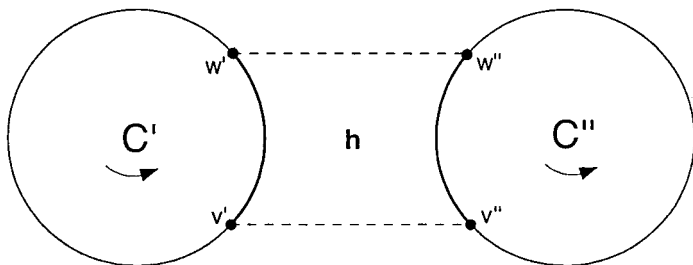

FIG. 2. A coherent block.

Suppose now that Γ is a 3-gem, and let C', C'' be $\{p, q\}$ -residues of Γ belonging to different components of $\Gamma_{\hat{r}}$. Let Ω be a maximal $(\{p, q\}, r)$ -block, connecting C' with C'' and suppose that Ω has length h . Denote by $\Gamma(\Omega)$ the 3-gem obtained from Γ in the following way:

- delete all the vertices and the edges of Ω ;
- weld the “hanging” edges of the same colour which in Γ have r -adjacent endpoints belonging to Ω (see Fig. 3).

The graph $\Gamma(\Omega)$ is said to be *obtained by cancelling Ω in Γ* .

LEMMA 3.1. *The graphs Γ and $\Gamma(\Omega)$ represent the same 3-manifold.*

Proof. Assume for the block Ω the notations given in Fig. 1. Since v'_1 and v''_1 belong to different components of $\Gamma_{\hat{r}}$, the r -edge b_1 , together with its endpoints v'_1, v''_1 , is a dipole of type 1 in Γ . The cancellation of this dipole produces a dipole of type 2 involving the r -coloured edge b_2 . The sequence of cancellations of this dipole and of the resulting dipoles of type 2 successively involving b_3, \dots, b_h leads to $\Gamma(\Omega)$. ■

Remark 3.1. It is important to note that Γ and $\Gamma(\Omega)$ have the same number of $\{r, s\}$ -residues, for $s \neq p, q, r$.

Notice that $\Gamma(\Omega)$ is obtained from Γ by means of a “polyhedral gluing” in the sense of Definition 8 of [7]. For this reason, we say that the $(\{p, q\}, r)$ -block Ω is a *gluing subgraph of Γ* (connecting C' with C'' by colour r).

After this operation, the $\{p, q\}$ -residues C' and C'' give rise to a unique $\{p, q\}$ -residue C in $\Gamma(\Omega)$. Moreover, if C' and C'' are oriented and the block Ω is coherent with these orientations, C inherits an orientation in a natural way.

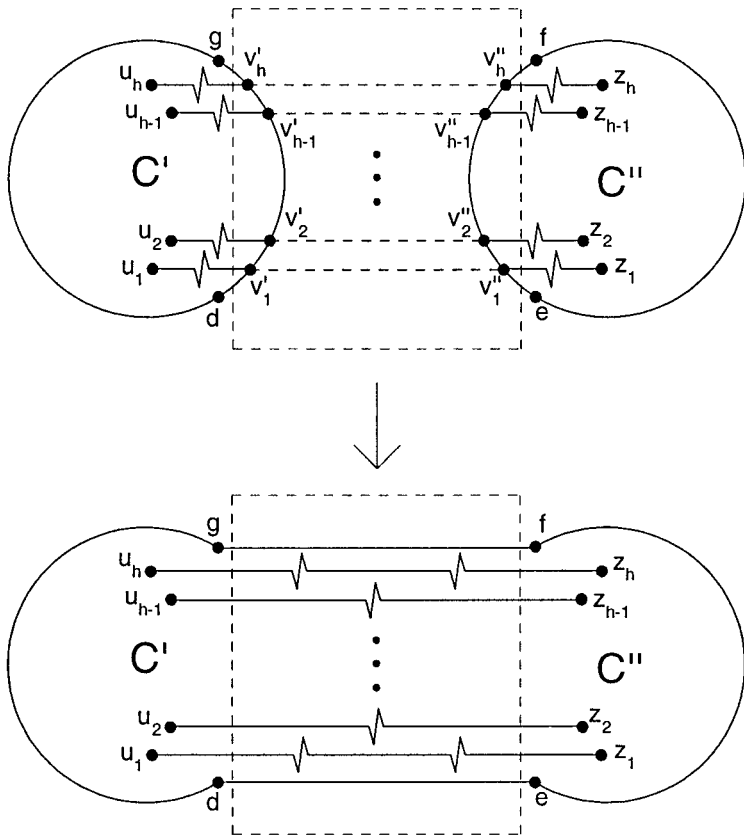
FIG. 3. From Γ to $\Gamma(\Omega)$.

4. FROM 6-TUPLES TO 3-MANIFOLDS OF GENUS 2

We recall now the possibility of representing all 3-manifolds of genus $g \leq 2$ via crystallizations defined by 6-tuples of integers satisfying simple conditions [3].

Let $\tilde{\mathcal{F}}$ be the set of the 6-tuples

$$f = (h_0, h_1, h_2; q_0, q_1, q_2)$$

of integers satisfying the following conditions:

- (I) $h_i > 0$, for each $i \in \mathbf{Z}_3$;
- (II) all h_i 's have the same parity;

(III) $0 \leq q_i < h_{i-1} + h_i = 2l_i$, for each $i \in \mathbf{Z}_3$;

(IV) all q_i 's have the same parity.

Notation. From now on, the operations on the q_i components will be considered mod $2l_i$ and, according to (III), q_i is always the least non-negative integer of the class.

Let $\tilde{\mathcal{G}} = \{\Gamma(f) \mid f \in \tilde{\mathcal{F}}\}$ be the class of 4-coloured graphs $\Gamma(f)$ whose vertices are the elements of the set

$$V(f) = \bigcup_{i \in \mathbf{Z}_3} \{i\} \times \mathbf{Z}_{2l_i},$$

and whose coloured edges are defined by means of the following four fixed-point-free involutions on $V(f)$:⁴

$$\iota_0(i, j) = (i, j + (-1)^j), \quad (1)$$

$$\iota_1(i, j) = (i, j - (-1)^j), \quad (2)$$

$$\iota_2(i, j) = \begin{cases} (i+1, -j-1) & \text{if } j = 0, \dots, h_i-1 \\ (i-1, 2l_i-j-1) & \text{if } j = h_i, \dots, 2l_i-1 \end{cases} \quad (3)$$

$$\iota_3(i, j) = \rho \iota_2 \rho^{-1}, \quad (4)$$

where $\rho: V(f) \rightarrow V(f)$ is the bijection defined by

$$\rho(i, j) = (i, j + q_i).$$

To complete the 4-coloured graph $\Gamma(f)$, join the vertex v with the vertex w by a c -coloured edge ($c \in \mathcal{A}_3$) if and only if $w = \iota_c(v)$. Observe that, by (4), there is a 2-edge joining v_1 with v_2 if and only if there is a 3-edge joining $\rho(v_1)$ and $\rho(v_2)$.

The graph $\Gamma(f)$ contains three $\{0, 1\}$ -residues C_i of length $2l_i$, whose vertices are the elements of $V(f)$ having i as first coordinate. The natural cyclic ordering on \mathbf{Z}_{2l_i} induces an orientation on each $\{0, 1\}$ -residue C_i and the bijection ρ acts on each C_i as a rotation of amplitude q_i according to this fixed orientation. Moreover, for each i , there exist a unique maximal $(\{0, 1\}, 2)$ -block B_i and a unique maximal $(\{0, 1\}, 3)$ -block B'_i , both of length h_i , connecting C_i with C_{i+1} . All these blocks are coherent with the orientations of the $\{0, 1\}$ -residues.

The map ρ is an automorphism of $\Gamma(f)$ exchanging colour 2 with colour 3 and, only in case of q_i odd, exchanging colour 0 with colour 1; it is easy

⁴ Here and in the following the arithmetic on $V(f)$ is mod 3 in the first coordinate and mod $2l_k$ in the second coordinate of each vertex $(h, k) \in V(f)$.

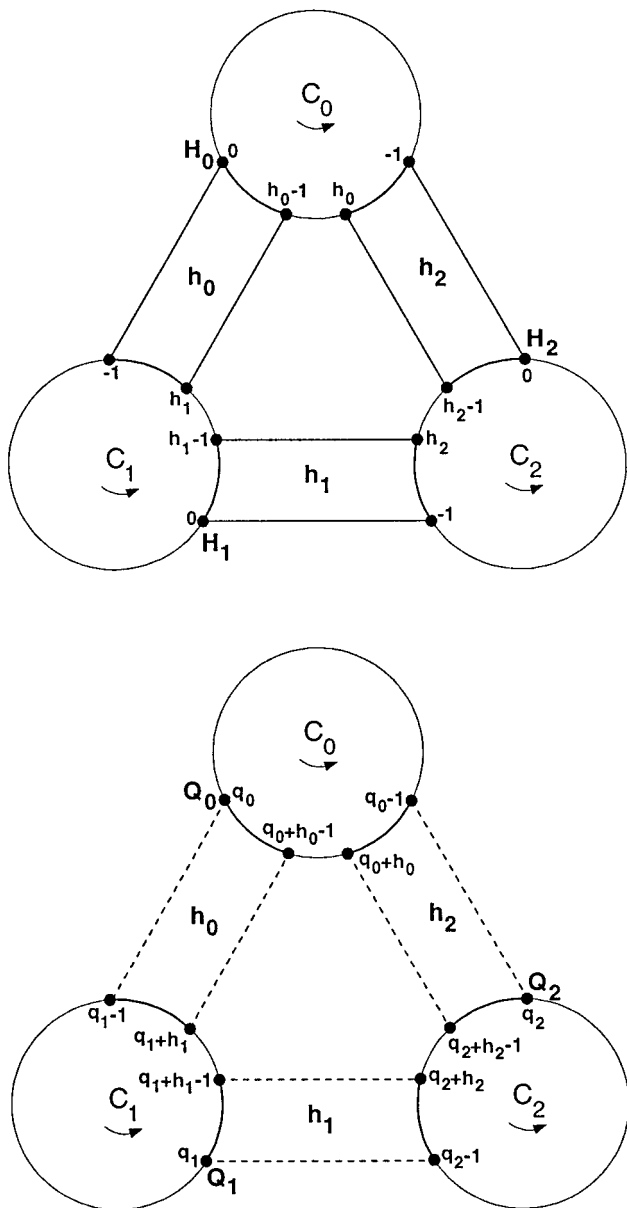

FIG. 4. The 3-residues $\Gamma(f)_3$ and $\Gamma(f)_2$.

to see that ρ sends each block B_i in B'_i . Finally, note that $\Gamma(f)$ is bipartite because of condition (IV).

We shall represent $\Gamma(f)$ by means of a planar embedding of its residues $\Gamma(f)_3$ and $\Gamma(f)_2$ (see Fig. 4). The whole graph $\Gamma(f)$ arises by gluing $\Gamma(f)_3$ and $\Gamma(f)_2$ in the three cycles C_0, C_1, C_2 , which are the $\{0, 1\}$ -residues of $\Gamma(f)$. The graph $\Gamma(f)$ admits a 2-cell embedding, which is regular in the sense of [9], into an orientable surface of genus two. This embedding can be obtained in a standard way using the construction described in [9].

We point out that in Figs. 4–10 the thin arcs are edges of the graph (i.e., there are no vertices in their interior).

Remark 4.1. Suppose now that Γ is a bipartite 4-coloured graph such that:

— $\Gamma_{\{0,1\}}$ consists of three $\{0, 1\}$ -residues C_i of length $2l_i = h_{i-1} + h_i$, with a given orientation;

— for each i , there exist a unique maximal $(\{0, 1\}, 2)$ -block B_i and a unique maximal $(\{0, 1\}, 3)$ -block, connecting C_i with C_{i+1} , both of length $h_i > 0$ and both coherent with the orientations of C_i and C_{i+1} .

Let H_i (resp. Q_i) be the key-vertex of B_i (resp. B'_i) belonging to C_i . Then Γ is the graph $\Gamma(h_0, h_1, h_2; q_0, q_1, q_2)$, where q_i is the distance from H_i to Q_i according to the orientation of C_i . Observe that all q_i 's have the same parity since Γ is bipartite.

Denote by \mathcal{F} the subset of $\tilde{\mathcal{F}}$ consisting of the 6-tuples f such that:

(V) $h_i + q_i$ is odd, for each $i \in \mathbf{Z}_3$;

(VI) $\Gamma(f)$ contains exactly three $\{2, 3\}$ -residues.

Then $\Gamma(f) \in \tilde{\mathcal{G}}$ is a crystallization of a 3-manifold of genus $g \leq 2$ if and only if $f \in \mathcal{F}$ [3]. We shall call *admissible* each 6-tuple belonging to \mathcal{F} . Observe that, as a consequence of (II) and (V), $q_i \neq h_j$ for each $i, j \in \mathbf{Z}_3$.

Set $\mathcal{G} = \{\Gamma(f) \mid f \in \mathcal{F}\}$; the crystallizations of \mathcal{G} are 2-symmetric in the sense of [3] and hence they represent 2-fold branched coverings of S^3 . Moreover, if M is a 3-manifold of genus $g \leq 2$, then there exists an $f \in \mathcal{F}$ such that $\Gamma(f) \in \mathcal{G}$ is a crystallization of M [3]. Thus, the set of all admissible 6-tuples gives a *complete catalogue of all 3-manifolds of genus $g \leq 2$* (see [2]).

The open problem of classifying 3-manifolds of genus 2 can be translated into the following question: when do two admissible 6-tuples represent the same manifold?

In this direction, it is important to find elementary transformations on admissible 6-tuples, which change the associated graph but do not change

the represented manifold. The present paper describes an elementary transformation of this type, which is called *2-symmetric*, since it can be obtained by considering standard sequences of dipole moves which change a given 2-symmetric crystallization $\Gamma(f) \in \mathcal{G}$ to another 2-symmetric crystallization $\Gamma' = \Gamma(f') \in \mathcal{G}$. The induced 2-symmetric transformation changes the admissible 6-tuple f into the admissible 6-tuple f' representing the same manifold.

We claim that for particular values of the parameters of f , the graph $\Gamma(f)$ represents a 3-manifold of genus 0 or 1.

LEMMA 4.1. *Let $(h_0, h_1, h_2; q_0, q_1, q_2)$ be an admissible 6-tuple and let (i, j, k) be any permutation of \mathbf{Z}_3 .*

(a) *If $q_i = q_j = 0$ then $\Gamma(h_0, h_1, h_2; q_0, q_1, q_2)$ represents the lens space $L(l_k, q_k/2)$.*

(b) *If $q_0 = q_1 = q_2 = 0$ then $\Gamma(h_0, h_1, h_2; q_0, q_1, q_2)$ represents \mathbf{S}^3 .*

Proof. (a) By deleting all dipoles involving the 2- and 3-edges connecting C_i with C_j we obtain the “normal” crystallization of the lens space $L(l_k, q_k/2)$ (see [4]). (b) $L(l_k, 0) \cong \mathbf{S}^3$. ■

5. THE 2-SYMMETRIC TRANSFORMATION

Let $\Gamma(f) \in \mathcal{G}$ be the crystallization of a 3-manifold M defined by the 6-tuple $f = (h_0, h_1, h_2; q_0, q_1, q_2) \in \mathcal{F}$. Moreover, assume the notation of the previous section and suppose the cycles C_i oriented according to the natural cyclic ordering on \mathbf{Z}_{2l_i} (see Fig. 4).

Delete the following edges from $\Gamma(f)$:

- all the h_1 2-edges connecting C_1 with C_2 ,
- the 1-edge of C_0 connecting $(0, -1)$ with $(0, 0)$,
- the edge a of C_0 connecting $(0, h_0 - 1)$ with $(0, h_0)$.⁵

Denote by $\tilde{\Gamma}(f)$ the resulting 4-coloured graph with boundary.

Let now $\Gamma(h_1)$ be the following 4-coloured graph with boundary: (see Fig. 5).

Remark 5.1. All vertices of $\Gamma(h_1)$ are boundary vertices with respect to colour 2. Moreover, v'_1 and v''_1 are boundary vertices with respect to colour 1, and v'_{h_1} and v''_{h_1} are boundary vertices with respect to colour 0 (resp. 1) if the h_i 's are odd (resp. even), i.e., if a has colour 0 (resp. 1).

⁵ Note that a has colour 0 (resp. 1) if h_0 is odd (resp. even).

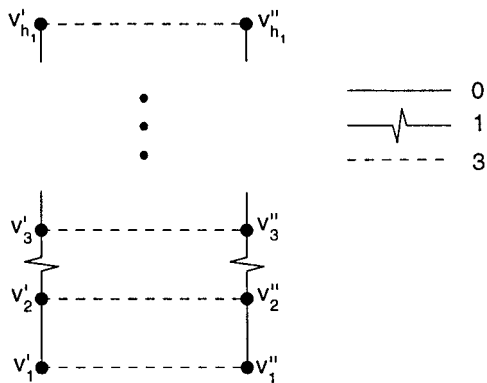

FIG. 5. $\Gamma(h_1)$.

Now connect:

- the vertex $(0, 0)$ (resp. $(0, -1)$) of $\tilde{T}(f)$ with the vertex v'_1 (resp. v''_1) of $\Gamma(h_1)$ by a 1-edge,
- the vertex $(0, h_0 - 1)$ (resp. $(0, h_0)$) of $\tilde{T}(f)$ with the vertex v'_{h_1} (resp. v''_{h_1}) of $\Gamma(h_1)$ by a $\gamma(a)$ -edge (recall the previous remark),
- the vertices $(1, 0), \dots, (1, h_1 - 1)$ of $\tilde{T}(f)$ respectively with the vertices v'_1, \dots, v'_{h_1} of $\Gamma(h_1)$ by 2-coloured edges,
- the vertices $(2, -1), (2, -2), \dots, (2, -h_1 = h_2)$ of $\tilde{T}(f)$ respectively with the vertices $v''_1, v''_2, \dots, v''_{h_1}$ of $\Gamma(h_1)$ by 2-coloured edges.

Denote by $G(f)$ the resulting 4-coloured graph (without boundary).

Note that $\Gamma(h_1)$ is the subgraph of $G(f)_2$ induced by the set of vertices $\{v'_1, \dots, v'_{h_1}, v''_1, \dots, v''_{h_1}\}$.

The $\{0, 1\}$ -residue C_0 of $\Gamma(f)$ splits in $G(f)$ into two different components C'_0 and C''_0 , where:

- the sequence of the vertices $(0, 0), \dots, (0, h_0 - 1)$ of $\Gamma(f)$ followed by the sequence of the vertices $v'_{h_1}, v'_{h_1 - 1}, \dots, v'_1$ of $\Gamma(h_1)$ gives all consecutive vertices of C'_0 ;
- the sequence of the vertices $(0, h_0), (0, h_0 - 1), \dots, (0, -1)$ of $\Gamma(f)$ followed by the sequence of the vertices v''_1, \dots, v''_{h_1} of $\Gamma(h_1)$ gives all consecutive vertices of C''_0 .

The graph $G(f)_3$ has two components Ω' and Ω'' ; Ω' (resp. Ω'') has two $\{0, 1\}$ -residues C'_0, C_1 (resp. C''_0, C_2) of length $h_0 + h_1$ (resp. $h_1 + h_2$), connected by “parallel” 2-edges. Hence, the $(\{0, 1\}, 3)$ -block $\Gamma(h_1)$ is a gluing subgraph of $G(f)$ (connecting C'_0 with C''_0 by colour 3) of length h_1 .

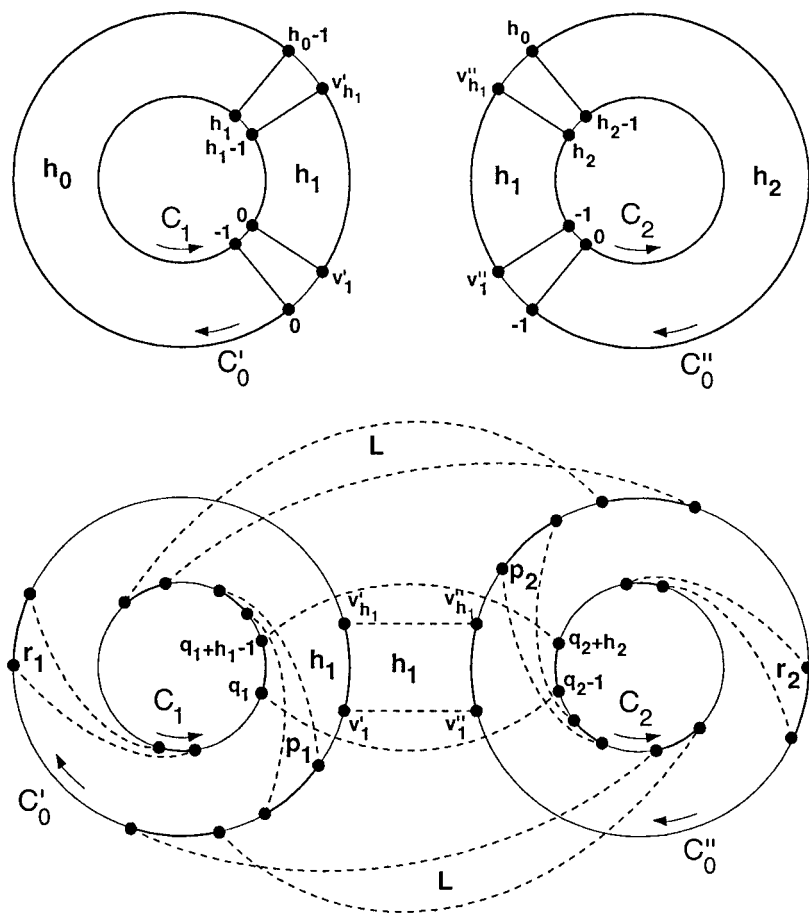

FIG. 6. The 3-residues $G(f)_3$ and $G(f)_2$.

Moreover, the graph obtained by cancelling $\Gamma(h_1)$ in $G(f)$ is $\Gamma(f)$. This proves that $G(f)$ represents the 3-manifold M . (see Fig. 6.)

We are now going to show that, by choosing another suitable gluing subgraph of $G(f)$, we can obtain a new crystallization $\Gamma(f') \in \mathcal{G}$ of the 3-manifold M , depending on a different 6-tuple $f' \in \mathcal{F}$. To achieve this goal, relabel the vertices of C'_0 , C''_0 and C_2 of $G(f)$ in the following way:

— label the vertices of C'_0 by $(0', j)$, $j \in \mathbf{Z}_{2l_1-1}$, so that in the increasing sequence $(0', 0), \dots, (0', 2l_1-1)$ the vertices are consecutive and so that the vertices v'_i of C'_0 are labelled by $(0', q_1 + h_1 - i)$, for each $i = 1, \dots, h_1$;

— label the vertices of C''_0 by $(0'', j)$, $j \in \mathbf{Z}_{2l_2-1}$, so that in the increasing sequence $(0'', 0), \dots, (0'', 2l_2-1)$ the vertices are consecutive and

so that the vertices v_i'' of C_0'' are labelled by $(0'', q_2 + i - 1)$, for each $i = 1, \dots, h_1$;

— label the vertices of C_2 so that the second component of $(2, j)$ becomes $(2, j - h_2)$, for each $j \in \mathbb{Z}_{2h_2 - 1}$.

Assume on C_0' and C_0'' the orientations induced by the cyclic ordering of their vertex labellings: the gluing subgraph $\Gamma(h_1)$ is coherent with these orientations and its cancellation restores the original orientation on C_0 . (see Fig. 7.)

Remark 5.2. The subgraph $\Gamma'(h_1)$ of $G(f)_2$ induced by the set of vertices $\{(1, q_1), \dots, (1, q_1 + h_1 - 1), (2, q_2), \dots, (2, q_2 + h_1 - 1)\}$ is a gluing

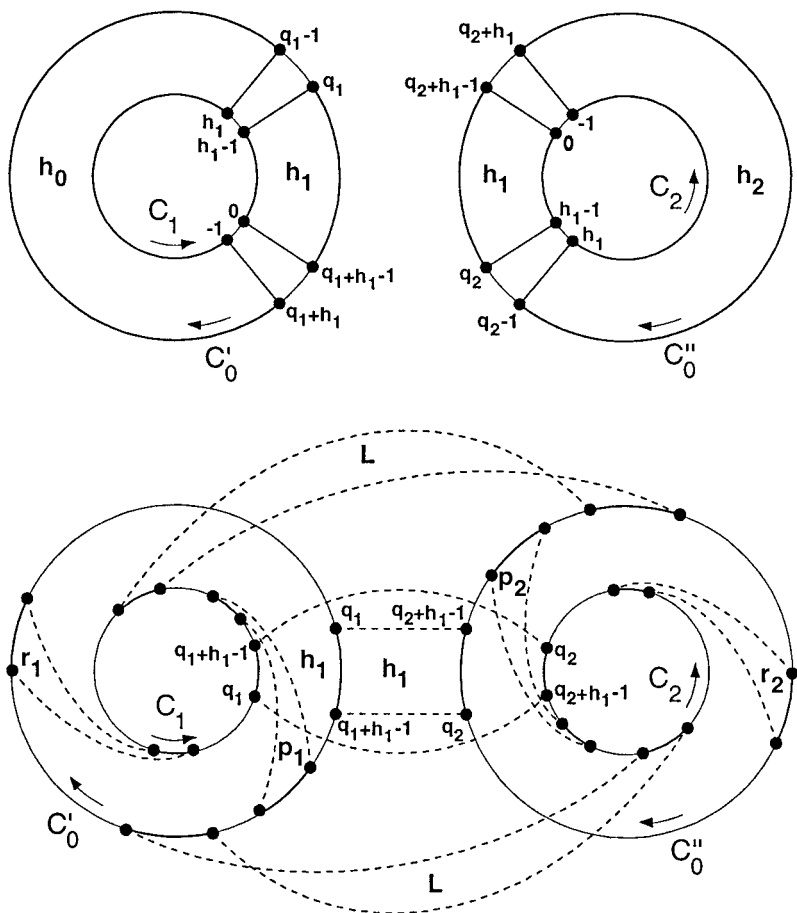

FIG. 7. The 3-residues $G(f)_3$ and $G(f)_2$.

subgraph of $G(f)$, connecting C_1 with C_2 by colour 3. The 4-coloured graph obtained by cancelling $\Gamma'(h_1)$ in $G(f)$ is c.p.-isomorphic to $\Gamma(f)$. This follows immediately since the involution on $V(G(f))$ exchanging $(1, i)$ with $(0', i)$, for each $i = 0, 1, \dots, h_0 + h_1$, and $(2, j)$ with $(0'', j)$, for each $j = 0, 1, \dots, h_1 + h_2$ is a c.p.-automorphism of $G(f)$ sending $\Gamma(h_1)$ to $\Gamma'(h_1)$.

Let now Θ (resp. Θ') denote the unique gluing subgraph of $G(f)$ connecting C_1 with C_0'' (resp. C_0' and C_2) by colour 3. As can be easily checked, Θ and Θ' are nonvoid if and only if $q_0 \neq 0$. The involutory c.p.-automorphism defined in previous remark sends Θ to Θ' and therefore the 4-coloured graphs respectively obtained by deleting Θ and Θ' in $G(f)$ are c.p.-isomorphic. From now on, we focus our attention on the 4-coloured graph Γ' obtained by cancelling Θ in $G(f)$. In fact, this is the unique graph obtained by cancelling gluing subgraphs in $G(f)$ connecting $\{0, 1\}$ -residues by colour 3, which is, in general, different from $\Gamma(f)$, up to c.p.-isomorphisms. It is straightforward that Γ' still represents the 3-manifold M . Moreover, the following result holds:

THEOREM 5.1. *Let $f = (h_0, h_1, h_2; q_0, q_1, q_2)$ be an admissible 6-tuple such that $q_0 \neq 0$ and let $f' = (h'_0, h'_1, h'_2; q'_0, q'_1, q'_2)$ be the 6-tuple defined by the following rules:*

$$\begin{cases} h'_0 = h_0 + h_1 - q_0 \\ h'_1 = q_0 \\ h'_2 = h_2 + h_1 - q_0 \end{cases} \quad \begin{cases} q'_0 = h_0 + h_1 + h_2 - 2q_0 \\ q'_1 = q_0 + q_1 + h_1 \\ q'_2 = q_0 + q_2 + h_1 \end{cases}, \quad \text{if } 0 < q_0 < h_0, h_2; \quad (5)$$

$$\begin{cases} h'_0 = q_0 + h_1 - h_2 \\ h'_1 = h_0 + h_2 - q_0 \\ h'_2 = q_0 + h_1 - h_0 \end{cases} \quad \begin{cases} q'_0 = h_1 \\ q'_1 = q_0 + q_1 - h_2 \\ q'_2 = q_0 + q_2 - h_0 \end{cases}, \quad \text{if } q_0 > h_0, h_2; \quad (6)$$

$$\begin{cases} h'_0 = h_1 \\ h'_1 = h_0 \\ h'_2 = h_1 + h_2 - h_0 \end{cases} \quad \begin{cases} q'_0 = h_1 + h_2 - q_0 \\ q'_1 = q_1 \\ q'_2 = 2q_0 + q_2 + h_1 - h_0 \end{cases}, \quad \text{if } h_0 < q_0 < h_2; \quad (7)$$

$$\begin{cases} h'_0 = h_1 + h_0 - h_2 \\ h'_1 = h_2 \\ h'_2 = h_1 \end{cases} \quad \begin{cases} q'_0 = h_1 + h_0 - q_0 \\ q'_1 = 2q_0 + q_1 + h_1 - h_2, \\ q'_2 = q_2 \end{cases}, \quad \text{if } h_2 < q_0 < h_0. \quad (8)$$

Then f' is an admissible 6-tuple and the 4-coloured graphs $\Gamma(f)$ and $\Gamma(f')$ represent the same manifold.

Proof. With the previous assumptions and notation, it suffices to show that the 4-coloured graph Γ' obtained by cancelling θ in $G(f)$ is c.p.-isomorphic to $\Gamma(f')$.

First, exchange the names of the two cycles C'_0 and C_1 , together with the first components in the labelling of their vertices. After this relabelling, θ becomes the unique gluing subgraph of $G(f)$ connecting C'_0 with C''_0 by colour 3; denote by L the length of θ .

Figure 8 sketches, with the usual conventions, the graphs $G(f)_3$ and $G(f)_2$; here we also point out the labelling of some "strategic" vertices of $G(f)$. The computation of the integers L, p_1, p_2, r_1, r_2 , depending on the components of f , is described in Table I.

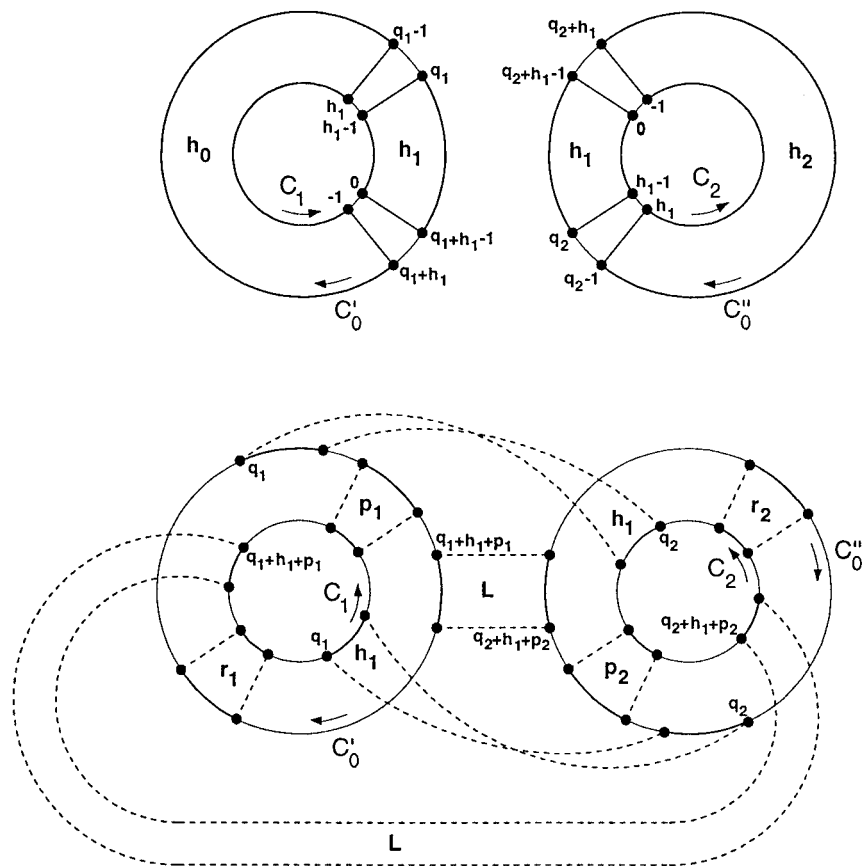

FIG. 8. The 3-residues $G(f)_3$ and $G(f)_2$.

TABLE I

	L	p_1	p_2	r_1	r_2
If $0 < q_0 < h_0, h_2$	q_0	0	0	$h_0 - q_0$	$h_2 - q_0$
If $q_0 > h_0, h_2$	$h_0 + h_2 - q_0$	$q_0 - h_2$	$q_0 - h_0$	0	0
If $h_0 < q_0 < h_2$	h_0	0	$q_0 - h_0$	0	$h_2 - q_0$
If $h_2 < q_0 < h_0$	h_2	$q_0 - h_2$	0	$h_0 - q_0$	0

Note that:

- (A) $p_1 \neq 0$ if and only if $r_2 = 0$,
- (B) $p_2 \neq 0$ if and only if $r_1 = 0$

Now, we are going to look into the shape of Γ'_3 and Γ'_2 . It is clear that, by cancelling Θ in $G(f)$, the two $\{0, 1\}$ -cycles C'_0 and C''_0 of $G(f)$ give rise to a unique $\{0, 1\}$ -cycle C_0 of Γ' ; moreover, since the length of C'_0 (resp. C''_0) is $h_0 + h_1$ (resp. $h_1 + h_2$), the length of C_0 is $h_0 + 2h_1 + h_2 - 2L$. Since the gluing subgraph Θ is coherent with the orientations on C'_0 and C''_0 , the cycle C_0 inherits an orientation in a natural way. On the other hand, the length of C_1 (resp. C_2) in Γ' is still $h_0 + h_1$ (resp. $h_1 + h_2$). Hence, the 3-coloured graphs Γ'_3 and Γ'_2 can be sketched as in Figs. 9 and 10 respectively.

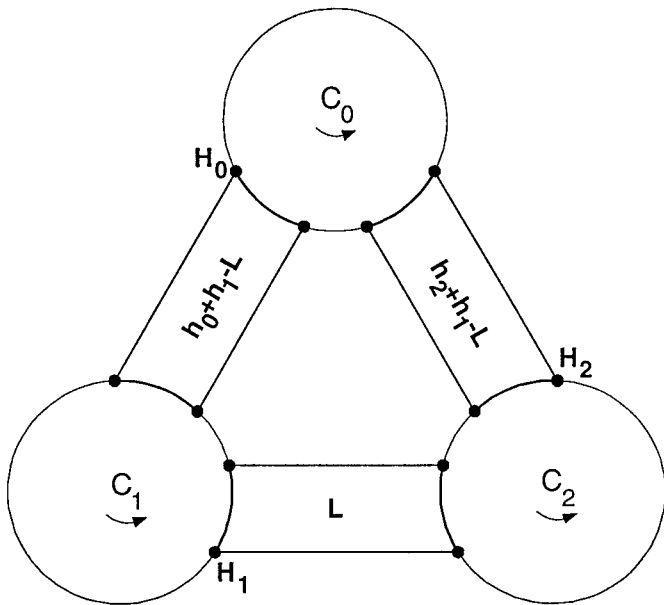

FIG. 9. The 3-residue Γ'_3 .

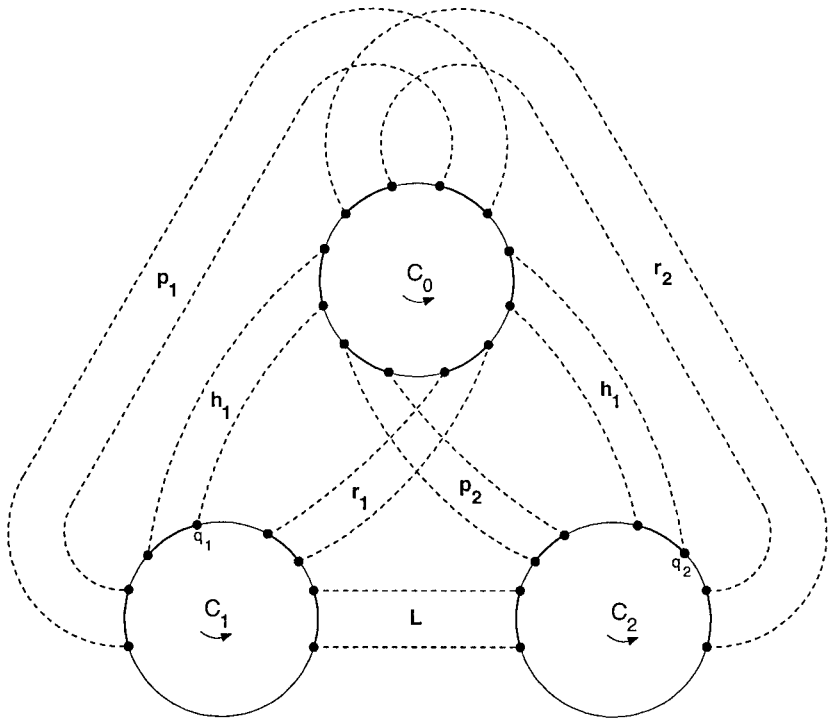

FIG. 10. The residue Γ_2 .

By properties (A) and (B), it is easy to check that, in all four cases of Table I, the graph Γ_2 is planar and has the shape of Fig. 9, where the numbers inside the strips can be computed by Table I.

The graph Γ' satisfies the assumptions of Remark 4.1 and hence Γ' is c.p.-isomorphic to $\Gamma(f') \in \tilde{\mathcal{G}}_2$, where $f' = (h_0 + h_1 - L, L, h_1 + h_2 - L; q'_0, q'_1, q'_2)$.

We are now going to compute q'_1, q'_2 and q'_0 . If H_i (resp. Q_i) denotes the key-vertex of B_i (resp. B'_i) belonging to $C_i, i=0, 1, 2$, then q'_i is the distance from H_i to Q_i according to the orientation of C_i . Now, H_1 (resp. H_2) is the vertex of $G(f)$ which is 2-adjacent with $(0', q_1 + h_1 + p_1 + L - 1)$ (resp. with $(0'', q_2 + h_1 + p_2 - 1)$) in $G(f)$. On the other hand, the vertex which is 2-adjacent with $(1, 0)$ (resp. with $(2, 0)$) in $G(f)$ is $(0', q_1 + h_1 - 1)$ (resp. $(0'', q_2 + h_1 - 1)$); hence, the distance from H_1 to $(1, 0)$ (resp. from H_2 to $(2, 0)$), according to the orientation of C_1 (resp. C_2), equals the distance from $(0', q_1 + h_1 - 1)$ to $(0', q_1 + h_1 + p_1 + L - 1)$ (resp. from $(0'', q_2 + h_1 - 1)$ to $(0'', q_2 + h_1 + p_2 - 1)$), according to the orientation of C'_0 (resp. C''_0). Since Q_1 (resp. Q_2) is the vertex $(1, q_1 + h_1 + p_1)$ (resp. $(2, q_2 + h_1 + p_2 + L)$) of $G(f)$, we obtain

$$q'_1 = (p_1 + L) + (q_1 + h_1 + p_1) = 2p_1 + q_1 + h_1 + L,$$

$$q'_2 = p_2 + (q_2 + h_1 + p_2 + L) = 2p_2 + q_2 + h_1 + L.$$

Furthermore, H_0 is the vertex of C_0 which is 2-adjacent in Γ' with the vertex preceding H_1 in C_1 ; hence, H_0 is the vertex $(0', q_1 + h_1 + p_1 + L)$ in C_0 . In the same way, Q_0 is the vertex of C_0 which is 3-adjacent with $(1, q_1 + h_1 + p_1 - 1)$ in Γ' . Therefore, we have the two possibilities

$$Q_0 = \begin{cases} (0', q_1 + h_1) & \text{if } p_1 \neq 0 \\ (0'', q_2) & \text{if } p_1 = 0. \end{cases}$$

By recalling that $p_1 \neq 0$ if and only if $r_2 = 0$, we can conclude that, in both cases,

$$q'_0 = h_1 + r_1 + r_2.$$

The graph Γ' is c.p.-isomorphic to $\Gamma(f') \in \tilde{\mathcal{G}}$, where

$$f' = (h_0 + h_1 - L, L, h_1 + h_2 - L;$$

$$h_1 + r_1 + r_2, 2p_1 + q_1 + h_1 + L, 2p_2 + q_2 + h_1 + L).$$

Substituting in this expression the values of L, p_1, p_2, r_1 and r_2 of Table I we obtain (5), (6), (7), and (8); moreover, f' satisfies property (V) and, by Remark 2, property (VI). So, f' is an admissible 6-tuple and this completes the proof. ■

With the assumptions of Theorem 5.1, the transformation changing f into f' is said to be a *2-symmetric transformation*.

6. EQUIVALENCE OF ADMISSIBLE 6-TUPLES

The reader might suspect that different admissible 6-tuples can be associated to c.p.-isomorphic coloured graphs. This is true, since we can change the order of the three $\{0, 1\}$ -residues or their orientations and this choice leads to different 6-tuples arising from the same graph.

LEMMA 6.1. *If $f = (h_0, h_1, h_2; q_0, q_1, q_2)$ is an admissible 6-tuple, then the 6-tuples $(h_1, h_2, h_0; q_1, q_2, q_0)$, $(h_2, h_1, h_0; q_0, q_2, q_1)$, $(h_0, h_1, h_2; -q_0, -q_1, -q_2)$ are admissible and their associated graphs are c.p.-isomorphic to $\Gamma(f)$.*

Proof. See [2, Proposition 16]. ■

Let $\psi_1, \psi_2, \psi_3: \mathcal{F} \rightarrow \mathcal{F}$ be the relative maps on the set of all admissible 6-tuples:

$$\psi_1(h_0, h_1, h_2; q_0, q_1, q_2) = (h_1, h_2, h_0; q_1, q_2, q_0)$$

$$\psi_2(h_0, h_1, h_2; q_0, q_1, q_2) = (h_2, h_1, h_0; q_0, q_2, q_1)$$

$$\psi_3(h_0, h_1, h_2; q_0, q_1, q_2) = (h_0, h_1, h_2; -q_0, -q_1, -q_2)$$

These maps are bijections on \mathcal{F} such that $\psi_1^3 = \psi_2^2 = \psi_3^2 = 1$. Each of them sends an admissible 6-tuple to a (generally different) admissible 6-tuple associated to a c.p.-isomorphic graph.

Remark 6.1. We can interpret the action of ψ_3 as a change of orientation of the three $\{0, 1\}$ -residues C_0, C_1 and C_2 , the action of ψ_1 as a cyclic permutation $C_0 \rightarrow C_1 \rightarrow C_2 \rightarrow C_0$ and the action of ψ_2 as an exchange between C_1 and C_2 .

Let $\text{Aut}(\mathcal{F})$ be the group of all bijections of \mathcal{F} and let K be any subgroup of $\text{Aut}(\mathcal{F})$; then two admissible 6-tuples f, f' will be called *K-equivalent* if there exists $k \in K$ such that $f = k(f')$. As usual, we call a *K-orbit* any *K*-equivalence class of admissible 6-tuples, i.e., any element of \mathcal{F}/K .

Now, let H and H' be the following subgroups of $\text{Aut}(\mathcal{F})$:

$$H = \langle \psi_1, \psi_2, \psi_3 \rangle, \quad H' = \langle \psi_2, \psi_3 \rangle.$$

LEMMA 6.2. *The group H' is isomorphic to the Klein four group $\mathbf{Z}_2 \oplus \mathbf{Z}_2$ and the group H is isomorphic to the dihedral group D_6 of all symmetries of a regular hexagon. Moreover, $H = H' \cup H'\psi_1 \cup H'\psi_1^2$.*

Proof. The relations $\psi_1^3 = \psi_2^2 = \psi_3^2 = 1$, $\psi_2\psi_3 = \psi_3\psi_2$, $\psi_1\psi_3 = \psi_3\psi_1$ and $\psi_1\psi_2 = \psi_2\psi_1^2$ hold. Therefore, we get for H' the classical presentation of the Klein four-group: $H' \cong \langle \psi_2, \psi_3 \mid \psi_2^2, \psi_3^2, [\psi_2, \psi_3] \rangle \cong \mathbf{Z}_2 \oplus \mathbf{Z}_2$. To obtain the second result, define $r = \psi_1^{-1}\psi_3$, $s = \psi_3\psi_2$ and observe that both r and s commute with ψ_3 . By Tietze transformations, we have:

$$H \cong \langle \psi_1, \psi_2, \psi_3 \mid \psi_1^3, \psi_2^2, \psi_3^2, (\psi_1\psi_2)^2, [\psi_1, \psi_3], [\psi_2, \psi_3] \rangle,$$

$$H \cong \langle \psi_3, r, s \mid (\psi_3 r^{-1})^3, (\psi_3 s)^2, \psi_3^2, (\psi_3 r^{-1} \psi_3 s)^2,$$

$$\psi_3 r^{-1} \psi_3 r, \psi_3 s \psi_3 s^{-1} \rangle,$$

$$H \cong \langle \psi_3, r, s \mid \psi_3 r^{-3}, s^2, \psi_3^2, (r^{-1}s)^2, \psi_3^2, \psi_3^2 \rangle,$$

$$H \cong \langle r, s \mid s^2, r^6, (sr)^2 \rangle,$$

which is a classical presentation of D_6 . Finally, the last sentence holds since $|H:H'| = |\langle \psi_1 \rangle| = 3$ and $H' \cap \langle \psi_1 \rangle = \{1\}$. ■

Now, let $\overline{\mathcal{F}}_H = \mathcal{F}/H$; then each orbit of $\overline{\mathcal{F}}_H$ is composed by 12 (not necessarily distinct) admissible 6-tuples associated to c.p.-isomorphic 4-coloured graphs.

The *complexity* of an admissible 6-tuple $(h_0, h_1, h_2; q_0, q_1, q_2)$ is the integer

$$v(h_0, h_1, h_2; q_0, q_1, q_2) = h_0 + h_1 + h_2,$$

which is half the cardinality of $V(\Gamma(f))$. Since 6-tuples of the same H -orbit have the same complexity, we can translate the notion of complexity to H -orbits in an obvious way.

To avoid repetitions of c.p.-isomorphic graphs, it is very useful to select a canonical representative for each H -orbit.

LEMMA 6.3. *If ω is an H -orbit, then there exists a unique 6-tuple $f = (h_0, h_1, h_2; q_0, q_1, q_2) \in \omega$ such that the following conditions hold:*

- (a) $h_0 \leq h_1 \leq h_2$;
- (b) $q_0 \leq l_0$;
- (c) if $q_0 = 0, l_0$ then $q_1 \leq l_1$;
- (d) if $q_0 = 0, l_0$ and $q_1 = 0, l_1$ then $q_2 \leq l_2$;
- (e) if $h_0 = h_1$ then $q_0 \leq q_2$ and $q_2 \leq -q_0$;
- (f) if $h_0 = h_1$ and $q_2 = \pm q_0$ then $q_1 \leq h_1$;
- (g) if $h_1 = h_2$ then $q_0 \leq q_1$ and $q_1 \leq -q_0$;
- (h) if $h_1 = h_2$ and $q_1 = \pm q_0$ then $q_2 \leq h_2$;
- (i) if $h_0 = h_1 = h_2$ then $q_1 \leq q_2$.

Proof. By ψ_1 and ψ_2 we can permute h_0, h_1, h_2 in all possible ways and therefore condition (a) can be achieved. Conditions (b), (c), and (d) follow by a suitable application of ψ_3 . Conditions (e), (f), (g), (h), and (i) follow by a combined application of the three maps. The unicity of such an f is straightforward. ■

The 6-tuple f of the previous lemma is said to be the *canonical representative* of the H -orbit ω .

Remark 6.2. The catalogue of admissible 6-tuples contained in [2] lists the complete sequence of canonical 6-tuples associated to prime 3-manifolds of genus 2, up to complexity 21.

By means of 2-symmetric transformations, we can relate different H -orbits representing the same 3-manifold. For this purpose, let $\sigma: \mathcal{F} \rightarrow \mathcal{F}$ be the map

$$\sigma(h_0, h_1, h_2; q_0, q_1, q_2) = \begin{cases} (h'_0, h'_1, h'_2; q'_0, q'_1, q'_2) & \text{if } q_0 \neq 0 \\ (h_0, h_1, h_2; q_0, q_1, q_2) & \text{if } q_0 = 0, \end{cases}$$

where $h'_0, h'_1, h'_2, q'_0, q'_1, q'_2$ are the integers defined by (5), (6), (7), and (8).
 By direct computation, it is easy to check the following properties.

LEMMA 6.4. *Let $\sigma, \psi_2, \psi_3: \mathcal{F} \rightarrow \mathcal{F}$ be the maps introduced above. Then $\sigma^2 = 1, \sigma\psi_2 = \psi_2\sigma$ and $\sigma\psi_3 = \psi_3\sigma$.*

PROPOSITION 6.1. *Let f be an admissible 6-tuple. If f is H -equivalent to f' then $\sigma(f)$ is H' -equivalent (and therefore H -equivalent) to either $\sigma(f')$ or $\sigma(\psi_1(f'))$ or $\sigma(\psi_1^2(f'))$.*

Proof. By Lemma 6.2 there exists $h' \in H'$ and $e \in \{0, 1, 2\}$ such that $f = h'(\psi_1^e(f'))$. Hence, by Lemma 6.4: $\sigma(f) = \sigma(h'(\psi_1^e(f'))) = h'(\sigma(\psi_1^e(f')))$.

Let G be the subgroup of $\text{Aut}(\mathcal{F})$ generated by ψ_1, ψ_2, ψ_3 and σ :

$$G = \langle \psi_1, \psi_2, \psi_3, \sigma \rangle.$$

Moreover, let $\mathcal{F}_G = \mathcal{F}/G$ be the set of all G -orbits. Each G -orbit is a union of H -orbits and contains admissible 6-tuples associated with (in general) non-isomorphic graphs representing the same 3-manifold. Of course, if the orbits are very large, a significant simplification in the catalogue of admissible 6-tuples can be achieved. The main result of the next section supports this hope: in fact we shall prove that almost all of G -orbits contain infinitely many elements.

7. TRAPS AND TRAP-FREE ORBITS

Let r, s be positive integers such that $r \leq s$; then an admissible 6-tuple is said to be a *trap of type (r, s)* if it is H -equivalent to a 6-tuple $(r, r, s; q_0, 0, q_2)$ such that

$$(*) \quad q_0 + k(q_0 + q_2), q_2 + k(q_0 + q_2) \in \{0, r + 1, r + 2, \dots, s - 1\}, \text{ for each } k \geq 0,$$

where both $q_0 + k(q_0 + q_2)$ and $q_2 + k(q_0 + q_2)$ are considered mod $r + s$.⁶

⁶ Observe that condition (*) is equivalent to the following one of finite type:

$$(**) \quad q_0 + kd, q_2 + kd \in \{0, r + 1, r + 2, \dots, s - 1\}, \text{ for each } k = 0, \dots, (r + s)/d - 1, \text{ where } d = \text{GCD}(q_0 + q_2, r + s).$$

EXAMPLES. The 6-tuples $(1, 1, 1; 0, 0, 0)$, $(1, 1, 3; 2, 0, 2)$ and $(1, 1, 2p - 1; 0, 0, 2q)$ are traps respectively representing \mathbf{S}^3 , $\mathbf{S}^1 \times \mathbf{S}^2$ and the lens space $L(p, q)$, for each $0 < q < p$.

LEMMA 7.1. *If f is a trap of type (r, s) , then $\sigma(f)$ is a trap of the same type.*

Proof. f is H -equivalent to a 6-tuple $f' = (r, r, s; q_0, 0, q_2)$ verifying condition (*). By Proposition 6.1, $\sigma(f)$ is H -equivalent to either $\sigma(f') = (r, r, s; -q_0, 0, 2q_0 + q_2)$ or $\sigma(\psi_1(f')) = \psi_1(f')$ or $\sigma(\psi_1^2(f')) = (s, r, r; -q_2, q_0 + 2q_2, 0) = \psi_1^2(r, r, s; q_0 + 2q_2, 0, -q_2)$. Since $q \in \{0, r + 1, r + 2, \dots, s - 1\}$ if and only if $-q \in \{0, r + 1, r + 2, \dots, s - 1\}$, it is easy to see that the admissible 6-tuples $(r, r, s; q_0 + 2q_2, 0, -q_2)$ and $(r, r, s; -q_0, 0, 2q_0 + q_2)$ both verify condition (*) and therefore the statement is achieved. ■

COROLLARY 7.1. *Let f be an admissible 6-tuple. Then:*

- (a) *If f is a trap then its G -orbit is finite.*
- (b) *If f is not a trap then its G -orbit contains no trap.*

Proof. (a) There is a finite number of traps of a fixed type. (b) Trivial. ■

We shall call a *trap orbit* each G -orbit composed by traps and a *trap-free orbit* each G -orbit without traps. Here is the main result of this section.

THEOREM 7.1. *Each trap-free orbit representing a 3-manifold of genus 2 contains infinitely many elements associated to infinitely many non-isomorphic graphs.*

In order to prove this theorem we define the map $\delta: \mathcal{F} \rightarrow \mathbf{N}$, by

$$\delta(f) = v(\sigma(f)) - v(f).$$

Note that δ measures the variation of the complexity of f due to a 2-symmetric transformation.

From Theorem 5.1 we get:

$$\delta(h_0, h_1, h_2; q_0, q_1, q_2) = \begin{cases} 0 & \text{if } q_0 = 0 \\ h_1 - q_0 & \text{if } 0 < q_0 < h_0, h_2 \\ q_0 + h_1 - h_0 - h_2 & \text{if } q_0 > h_0, h_2 \\ h_1 - h_0 & \text{if } h_0 < q_0 < h_2 \\ h_1 - h_2 & \text{if } h_2 < q_0 < h_0. \end{cases} \quad (9)$$

Moreover, δ is constant in each H' -orbit, since Lemma 6.4 gives $\delta(h'(f)) = v(\sigma(h'(f))) - v(h'(f)) = v(h'(\sigma(f))) - v(h'(f)) = v(\sigma(f)) - v(f) = \delta(f)$, for each $h' \in H'$.

If $f = (h_0, h_1, h_2; q_0, q_1, q_2)$ is an admissible 6-tuple such that $h_0 \leq h_1 \leq h_2$ (for example a canonical one), then we have:

$$\delta(f) = \begin{cases} 0 & \text{if } q_0 = 0 \\ h_1 - q_0 & \text{if } 0 < q_0 < h_0 \\ h_1 - h_0 & \text{if } h_0 < q_0 < h_2 \\ q_0 + h_1 - h_0 - h_2 & \text{if } q_0 > h_2; \end{cases} \quad (10)$$

$$\delta(\psi_1(f)) = \begin{cases} 0 & \text{if } q_1 = 0 \\ h_2 - q_1 & \text{if } 0 < q_1 < h_0 \\ h_2 - h_0 & \text{if } h_0 < q_1 < h_1 \\ q_1 + h_2 - h_1 - h_0 & \text{if } q_1 > h_1; \end{cases} \quad (11)$$

$$\delta(\psi_1^2(f)) = \begin{cases} 0 & \text{if } q_2 = 0 \\ h_0 - q_2 & \text{if } 0 < q_2 < h_1 \\ h_0 - h_1 & \text{if } h_1 < q_2 < h_2 \\ q_2 + h_0 - h_2 - h_1 & \text{if } q_2 > h_2. \end{cases} \quad (12)$$

Proof of Theorem 7.1. Let ω be a trap-free orbit representing a 3-manifold of genus 2. We shall show that, for each $\tilde{f} \in \omega$, there exists $\tilde{f}' \in \omega$ such that $v(\tilde{f}') > v(\tilde{f})$. To achieve this fact, it suffices to find a 6-tuple $f' \in \omega$ with the same complexity of \tilde{f} and such that $\delta(f') > 0$. In fact, in this case, $\tilde{f}' = \sigma(f') \in \omega$ is such that $v(\tilde{f}') = v(f') + \delta(f') > v(f') = v(\tilde{f})$.

Let $f = (h_0, h_1, h_2; q_0, q_1, q_2)$ be a representative of the H -orbit of \tilde{f} such that $h_0 \leq h_1 \leq h_2$; therefore $f, \psi_1(f), \psi_1^2(f)$ are H -equivalent to \tilde{f} . By (11) $\delta(\psi_1(f)) > 0$ whenever $q_1 \neq 0$.

Suppose now $q_1 = 0$, then $q_0 \neq 0$ by Lemma 4.1; from (10) we get $\delta(f) > 0$ whenever $h_0 < h_1$.

It remains to examine the case $f = (h_0, h_0, h_2; q_0, 0, q_2)$. Let T be the set $\{0, h_0 + 1, h_0 + 2, \dots, h_2 - 1\}$. If $q_0 \notin T$ then $\delta(f) > 0$ and if $q_2 \notin T$ then $\delta(\psi_1^2(f)) > 0$. Let us suppose $q_0, q_2 \in T$; since ω is trap-free, the set $S = \{k > 0 \mid q_0 + k(q_0 + q_2) \notin T \text{ or } q_2 + k(q_0 + q_2) \notin T\}$ is not empty. Let m be the minimum of S . Then $q_0 + k(q_0 + q_2) \in T$ and $q_2 + k(q_0 + q_2) \in T$, for each $k = 1, \dots, m - 1$, and either (a) $q_0 + m(q_0 + q_2) \notin T$ or (b) $q_2 + k(q_0 + q_2) \notin T$. It is easy to check, by induction, that $f'_m = (\psi_1 \psi_2 \sigma)^m(f) = (h_0, h_0, h_2; q_0 + m(q_0 + q_2), 0, -q_0 - (m - 1)(q_0 + q_2))$ and $f''_m = (\psi_1 \psi_2 \sigma)^m(\psi_1 \psi_2(f)) = (h_0, h_0, h_2; q_2 + m(q_0 + q_2), 0, -q_2 - (m - 1)(q_0 + q_2))$ (recall that $q \in T$ if and only if $-q \in T$). If (a) holds then $\delta(f'_m) > 0$ and if (b) holds then $\delta(f''_m) > 0$. This proves the statement. \blacksquare

Remark 7.1. We point out that traps are really rare in the class of admissible 6-tuples. For example, the catalogue enclosed in [2] contains no traps among a list of nearly 700 canonical 6-tuples. This shows that there are no traps of complexity ≤ 21 representing prime 3-manifolds of genus 2.

8. MINIMAL 6-TUPLES AND ROOTS

The goal of producing a reduced catalogue of admissible 6-tuple representing all 3-manifolds of genus 2 suggests looking for a suitable representative for each G -orbit (a “super-canonical” 6-tuple), which is possibly minimal as regards complexity.

Let C be the set of all canonical 6-tuples. We say that $f \in C$ is *minimal* if $v(f') \geq v(f)$, for each 6-tuple f' G -equivalent to f . Moreover, we say that $f \in C$ is a *root* if $v(f') > v(f)$, for each 6-tuple f' G -equivalent and H -nonequivalent to f .

A minimal 6-tuple is a representative of minimal complexity of its G -orbits and a root is the unique minimal 6-tuple of the G -orbit. Although not every G -orbit admits a root, very often this is the case.

LEMMA 8.1. *Let f be a canonical 6-tuple. Then:*

- f is minimal if and only if $\delta(\psi_1^i(f)) \geq 0$, for $i = 0, 1, 2$;
- f is a root if and only if $\delta(\psi_1^i(f)) > 0$ whenever $\sigma(\psi_1^i(f)) \notin [f]_H$, for $i = 0, 1, 2$.

Proof. In one direction (\Rightarrow) the statement is trivial since $\sigma(f)$, $\sigma(\psi_1(f))$, $\sigma(\psi_1^2(f))$ are G -equivalent to f . To prove the converse, denote by Σ the graph whose vertex-set is the set C of all canonical 6-tuples and whose edge-set is defined by the following rule: join two different vertices f and f' by an edge iff there exist two admissible 6-tuples $\tilde{f} \in [f]_H$, $\tilde{f}' \in [f']_H$, such that $\tilde{f}' = \sigma(\tilde{f})$. The graph Σ is well defined because $\sigma^2 = 1$; moreover, it is an infinite graph without loops or multiple edges. Each connected component of Σ corresponds to a G -orbit and each vertex of Σ has degree ≤ 3 by Proposition 6.1: in fact, the vertices which are adjacent to a given vertex f are the canonical representatives of the H -orbits $[\sigma(f)]_H$, $[\sigma(\psi_1(f))]_H$, $[\sigma(\psi_1^2(f))]_H$ distinct from $[f]_H$. We are now going to prove that if f' is adjacent to f and $v(f') < v(f)$, then the other vertices which are adjacent to f have complexity $> v(f)$. First, if $\sigma(\psi_1(f))$ is not H -equivalent to f then $q_1 \neq 0$ and therefore $\delta(\psi_1(f)) > 0$ by (11). Moreover, from (10) we get $\delta(f) \geq 0$. Suppose now $\delta(\psi_1^2(f)) < 0$, then $h_0 < h_1$ by (12) and both $\delta(f)$, $\delta(\psi_1(f)) > 0$. As a consequence, any path in Σ whose

sequence of vertices is $f_0 = f, f_1, \dots, f_n$ has the following property: if $v(f) \leq v(f_1)$ (resp. $v(f) < v(f_1)$), then $v(f_i) \leq v(f_{i+1})$ (resp. $v(f_i) < v(f_{i+1})$), for each $i = 0, \dots, n-1$. Now, if $\delta(\psi_1^i(f)) \geq 0$ (resp. $\delta(\psi_1^i(f)) > 0$) whenever $\sigma(\psi_1^i(f)) \notin [f]_H$, for $i = 0, 1, 2$, then all vertices which are adjacent to f have not lower (resp. have greater) complexity; hence, each path of positive length starting from f ends in a vertex f' such that $v(f') \geq v(f)$ (resp. $v(f') > v(f)$) and therefore f is minimal (resp. is a root). ■

As a direct consequence of Lemma 13 we can find a complete characterization of minimal 6-tuples and roots.

THEOREM 8.1. *A canonical 6-tuple $f = (h_0, h_1, h_2; q_0, q_1, q_2)$ is minimal if and only if*

$$q_2 < h_0 \quad \text{or} \quad q_2 > h_1 + h_2 - h_0 \quad \text{or} \quad h_0 = h_1 < q_2 < h_2.$$

Moreover, each minimal 6-tuple is a root with the exception of the following cases:

(a) $h_0 = h_1 < q_2 < h_2$ and $q_2 \neq -q_0, (h_0 + h_2)/2$ and, when $q_1 = 0$, $q_2 \neq (h_0 + h_2)/2 - q_0$;

(b) $h_0 = h_1 < q_0 < h_2$ and $q_0 \neq -q_2, (h_0 + h_2)/2$ and, when $q_1 = 0$, $q_0 \neq (h_0 + h_2)/2 - q_2$.

Proof. From (10) and (11) we always get $\delta(f) \geq 0$ and $\delta(\psi_1(f)) \geq 0$. Moreover, $\delta(\psi_1^2(f)) \geq 0$ when either $q_2 < h_0$ or $q_2 > h_2 + h_1 - h_0$ or $h_0 = h_1 < q_2 < h_2$, by (12).

Now, if $q_i = 0$ then $\sigma(\psi_1^i(f)) \in [f]_H$, for $i = 0, 1, 2$. Therefore $\delta(\psi_1(f)) > 0$ whenever $\sigma(\psi_1(f)) \notin [f]_H$. On the other hand, it is easy to check that case (a) (resp. case (b)) includes all the minimal 6-tuples f such that $\delta(\psi_1^2(f)) = 0$ and $\sigma(\psi_1^2(f)) \notin [f]_H$ (resp. such that $\delta(f) = 0$ and $\sigma(f) \notin [f]_H$). ■

REFERENCES

1. J. Bracho and L. Montejano, The combinatorics of colored triangulations of manifolds, *Geom. Dedicata* **22** (1987), 308–328.
2. M. R. Casali, A catalogue of the genus two 3-manifolds, *Atti Sem. Mat. Fis. Univ. Modena* **37** (1989), 207–236.
3. M. R. Casali and L. Grasselli, 2-Symmetric crystallizations and 2-fold branched coverings of S^3 , *Discrete Math.* **87** (1991), 9–22.
4. A. Donati and L. Grasselli, Gruppo dei colori e cristallizzazioni “normali” degli spazi lenticolari, *Boll. Un. Mat. Ital. A* **6** (1982), 359–366.
5. M. Ferri, Una rappresentazione delle n -varietà topologiche triangolabili mediante grafi $(n+1)$ -colorati, *Boll. Un. Mat. Ital. B* **13** (1976), 250–260.

6. M. Ferri, Crystallisations of 2-fold branched coverings of S^3 , *Proc. Amer. Math. Soc.* **73** (1979), 271–276.
7. M. Ferri and C. Gagliardi, Crystallisation moves, *Pacific J. Math.* **100** (1982), 85–103.
8. M. Ferri, C. Gagliardi, and L. Grasselli, A graph-theoretical representation of PL-manifolds —A survey on crystallizations, *Aequationes Math.* **31** (1986), 121–141.
9. C. Gagliardi, Regular imbeddings of edge-coloured graphs, *Geom. Dedicata* **11** (1981), 397–414.
10. C. Gagliardi, Extending the concept of genus to dimension n , *Proc. Amer. Math. Soc.* **81** (1981), 473–481.
11. F. Harary, “Graph Theory,” Addison–Wesley, Reading, MA, 1969.
12. J. Hempel, “3-manifolds,” *Annals of Mathematics Studies*, Vol. 86, Princeton Univ. Press, Princeton, NJ, 1976.
13. P. J. Hilton and S. Wylie, “An Introduction to Algebraic Topology—Homology Theory,” Cambridge Univ. Press, Cambridge, UK, 1960.
14. J. F. P. Hudson, “Piecewise Linear Topology,” Benjamin, New York, 1969.
15. S. Lins, “Gems, Computers and Attractors for 3-Manifolds,” World Scientific, Singapore, 1995.
16. J. M. Montesinos, Lectures on branched coverings, in “Atti del Convegno di Studio sulla Geometria delle Varietà Differenziabili” (I. Cattaneo Gasparini, Ed.), pp. 127–167, Pitagora Editrice, Bologna, 1985.
17. M. Pezzana, Sulla struttura topologica delle varietà compatte, *Atti Sem. Mat. Fis. Univ. Modena* **23** (1974), 269–277.
18. C. Rourke and B. Sanderson, “Introduction to Piecewise-Linear Topology,” Springer-Verlag, Berlin/Heidelberg/New York, 1972.
19. H. Seifert and W. Threlfall, “A Textbook of Topology,” [English reprint], Academic Press, San Diego, 1980.
20. A. Vince, n -graphs, *Discrete Math.* **72** (1988), 367–380.